

**These clinic notes
are provided courtesy of
KCS Basketball Enterprises, LLC.
The notes were taken by Kevin Sivils at
a clinic given by
Coach Dick Bennett at the Louisiana High
School Coaches Association Convention
July 21-22, 1995.**



www.kcsbasketball.com
info@kcsbasketball.com

NOTES FROM LHSCA CONVENTION JULY 20-21, 1995
UNIVERSITY OF WISCONSIN HEAD COACH DICK BENNETT

SESSION I -Opening Comments/General Thoughts On Coaching:

Happy to be here in Baton Rouge - need to get used to the city as future daughter-in-law is from Baton Rouge.

Have my hands full at University of Wisconsin. Here is something to think about as a coach. If you have an opportunity to move on - think about what you have before you move on. I was a candidate for the Wisconsin job five times before I got the job.

You just do not know. You have to let things go. If you want it too badly - you won't get it - you must hand it over to God - you may get it.

I was smart enough to get a five year contract! (Joke) Is excited and scared at the same time.

The greatest influence you will ever have on youngsters as a coach will be at the high school level. Kids have been molded by the time they get to college. A college coach can only control the player's exterior.

You forfeit this influence at the college level. It is more businesslike. You really must try to keep it fun. Has managed to keep it fun.

IRONY OF THE SITUATION: The reason they hired him was the reason they used to turn him down. They wanted an NBA approach - now they just want solid hoops.

Has north & south players - can he play motion with these kids?

Influenced heavily by the Packers and Lombardi - (Need to read about Lombardi) - watched Packer practices as a youth with his father - **LOMBARDI FORMULA:** grind away until you get the execution you want.

Real goal of this clinic is to get coaches to think and reflect about things!

The following things are what Bennett wants to be identified for:

- 1) Team Defense
- 2) Shot selection
- 3) Taking care of the ball

TEAM DEFENSE keeps you in the game.

- if your defense creates offense for you , you can win.

- *team defense* keeps you in the game and will allow you to be competitive.

Need kids who play to win instead of kids who play to look good.

Told son to play to win with Charlotte Hornets - not to look good.

Teaching Approach: Has not varied from this in a long time.

Three areas:

1) *Offensive Fundamentals:*

- a) everything that goes on the offensive end of the floor can be broken down into fundamentals.
- b) passing and catching are big issue with Bennett - thinks they don't get done when things are tough for the offense. Make the situation tough for the opponent on offense and they won't pass and catch.

2) *Defensive Breakdowns:*

- a) must be broken down and repeated over and over
- b) this repetition teaches anticipation

3) *Team Offense As A Whole:*

- a) teach the offense as a whole (5-on-5 and/or 5-on-0)
- b) saves time for defense

Adds one feature to this on the practice floor: "game situations" works on this at the end of practice.

If Bennett doesn't like the way something works in 5-on-5 he addresses the mechanics of the faulty skill in the other two areas. Again, this is to allow more time for practice on defense.

His son says great shooters are those who fight for their feet (work to set their feet up for the shot when they catch the ball).

When pressing - do not extend your basic defense!

- really pressure the inbounders
- trap the first pass
- then sprint back and get into pack or push defense
(pack may be better because it stops penetration better!)
- press only the first part of the court.

BENNETT'S FIVE BIBLICAL PRINCIPLES !:

See Handout!

Has this handout laminated for his players. It is the only handout he gives them. Uses these principles in **EVERYTHING** he does as a coach. Applies them to offense and defense!

Started out trying to learn everything as a coach.

Now he tries to do less better and concentrate on learning about what he wants to do with his team.

Think about what you want to have happen.

Your concern must be how your players handle themselves.

HUMILITY:

Easy to teach humility at UW-GB. The players knew they were not great.

Knowing who you are is so vital. This basic concept runs contrary to what goes on today. Kids have an exalted opinion of themselves - inflated.

Know what your limitations are - know who you are. Then you can deal with things.

Help the kids know who they are. Then they can improve and feel comfortable.

PASSION:

Must have it. Find out what the kids feel passionately about!

UNITY:

DO NOT DIVIDE OUR HOUSE!

Conflicts must be resolved - do not leave until it is over.

SERVANTHOOD:

Make teammates better!

Defense - serving one another - screening and helping on defense.

Must get kids to serve one another - The Road To Greatness is in serving one another.

Cutters job is to create action - if he catches and flips the ball off STOP THINGS! - His job is to serve by creating action for others on offense.

THANKFULNESS:

Learn from each circumstance - the ugly stuff is what you learn from.

Really have to be with the kids and piece it together after the tough losses.

Sometimes you have to comeback on Monday.

The wisdom gained from TOUGH EXPERIENCES is the most valuable.

The strength to say THANK YOU when it happens is a blessing.

Must teach kids to ask why they aren't playing.

Ask them if they really want to know why?

-You're not good enough - if the kid accepts this then the learning process can begin.

George Lehman to Dick Bennett - The reason Terry Porter and Tony Bennett (his son) would take all of the abuse was they know Bennett loved them - so they would take all the crap and still listen to it all and learn from it. (Sivils note - They were also great players - were willing to take criticism)

Take the time to listen to criticism and failure and let it mold what you're doing. Put pride on the backburner and take the desire to learn and improve things and put them on the frontburner.

Wasn't smart enough to get into U. of Wisconsin - now he is the head coach there (Joke)

Teach who you are - **TEACH VALUES** - It eliminates inconsistency.

Be who you are - want the players to know who you are.

Closing thoughts to Session I:

- a) The objectives on the handout may change at UW-Madison - but probably won't
- b) Everything is organized around the Objectives part of the handout.

SESSION II - Defensive Approach:

- 1) Must set the Defense (transition - stopping the ball) This is critical
- 2) Pressuring the basketball is essential to destroy the comfort zone.
- 3) Help situations - screens etc.
- 4) Finish the play defensively - rebound/secure the turnover.

These defensive objectives can be measured.

The players must always have the laminated handout.

Bennett's defensive philosophy has changed with the times!

Based on idea of interrupting motion offense. Don't let people pass and catch - interrupt the ability to pass and catch. This was the push defensive concepts.

Game is now more of a North and South game instead of a East and West game. People try to get in the lane now - drive and kick it for 3's.

The penetration game is here to stay - it has made the offensive game better.

Has adjusted defensive philosophy to adjust to this. People were beating them because they forced action in their defense and their opponents were good enough to finish the offensive action/play.

Bennett thinks the 35 second shot clock really helps him and his style of play. The PACK defense really makes it hard to get the ball in the paint. This hurts the opponent's offensive attack and yet has not hurt his offensive attack any.

Push D - push the ball to the outside - contest all passes one pass away - interrupt ball movement
- on the line up the line denial

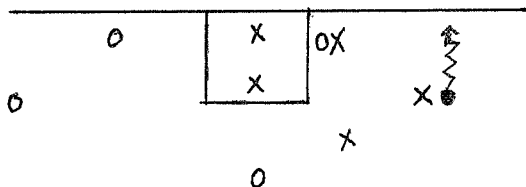

Pack D - stop all penetration to the middle - line up help positions so recovery is quicker.

- allows ball movement but still places tremendous pressure on the ball.

Push D was very effective against teams that were not explosive. More zone than man-to-man.

If was five people really reacting to the ball

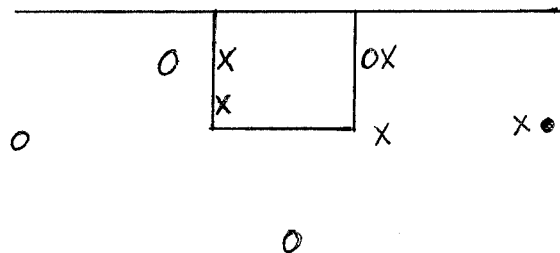

The only man in Push not guarding the ball who was concerned with his man was the man above the ball - his job was to eliminate ball reversal.

Get in pack - then when the ball is on a side get into push - had success with this.

REASONS FOR CHANGE: due to forced action

- 1) Weakside rebounding was poor to begin with
- 2) Rebounding was made more difficult with the help rotation
- 3) Fouling had become excessive

People couldn't run their offense but that was OK with them because they wanted to make plays.

THOUGHTS CONCERNING PACK AND THE CHANGES MADE:

- 1) Not going to give up the game
- 2) Offense wants to make the play - defense wants to force the extra/next pass.
- 3) Not going over the help as much
- 4) Not going to get beat on the dribble baseline

THOUGHTS ON POST DEFENSE:

The most difficult decision is how you are going to defend the post. This keys everything else.

1st Experiment:

- 1) stayed on top
- 2) tough offensive post players just created space

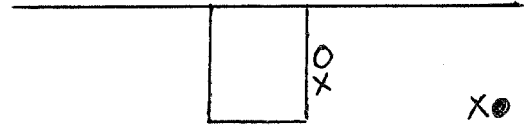

2nd Experiment:

- 1) our guy is bigger and stronger played this way
- 2) their guy is bigger and stronger dead front.

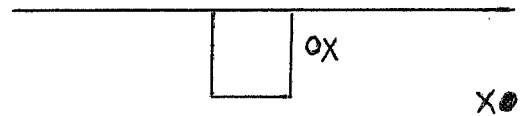

Now have gone back to just dead front. Will get help from on top and behind.
Use high hands to force the lob or bounce pass.

Not going to let the ball in the lane - going to keep the ball in front of us - gives up easy 3's & rhythm shots - the closeouts with high hands is the key to stopping the easy shots.

Must be great at anticipating going from help/recovery to onball defense with a great closeout.

Thoughts on closing out:

Key to closing out is to have your hands up.

1001 count breaks the ball's rhythm -

By coming out with your hands up high you have more cushion for your gap.

After a 1001 count you can drop your upper arms - **BUT YOU MUST KEEP YOUR FINGERS UP! THIS IS DONE AS LONG AS THE MAN IS STATIONARY!**

When they lost to Colorado State Boyd Grant told him after the game that the reason they lost was poor closeouts. Closeouts are now very important to him.

Closeout technique for feet - run and finish in a defensive slide - at least one slide to get to the ball.

Thinks technique is not as important as results are on defense. The only thing he is really concerned about technique wise is the high hands.

Know how you want the defense to finish. How they get there is OK - They just have to have high hands.

So much of offense is perception. It is what they see. If I am a shooter and the defender's hands are down I am going to think shot when I catch the ball. Hands up sends a no shot message.

Next to the ball defense:

Putting people in position to take away penetration - pass or dribble - and give you time on defense. The shot clock helps here.

Defense is really about buying time.

- get to post help on the lob
- get to a shooter

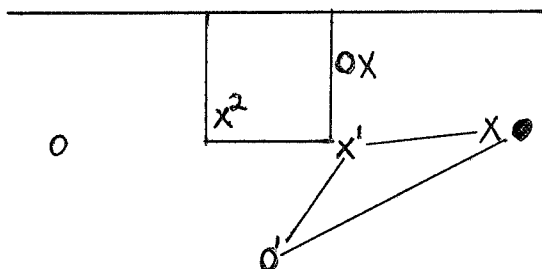

x1 no longer has to help - can start recovery sooner - this is his only real concern

Defense needs to feel good about forcing a pass on the perimeter.

x1 & x2 have taken away the seam to drive in diagram above. Go back to servanthood on the handout. Players must get to these spots on the pass! High closeout is critical.

DISCIPLINE IS THE MOST IMPORTANT THING ON DEFENSE!

Put up a picket fence against the great penetrator.

There are ways to stay closer to a great outside shooter and yet help. (Sivils note: did not explain just went on to next thought)

Determine what is going to get you beat - Then stop that one thing.

Doesn't watch film on opponent - watches film of his team.

Are they going to beat us with ball rotation and screens or are they going to beat us with penetration?

Must really work on defending screens if you allow the next pass. They will try to pin you in with screens.

People don't seem to set a lot of screens any more so maybe this will help.

Denial defense does not see as many screens - sees more penetration attempts.

Pack defense - always want the 4 guys off the basketball inside the 3 pt. line.

Handling screens:

- 1) When you are being screened the only thing you worry about is chasing your man
- 2) As soon as you know you are going to be screened get to your man
- 3) Touch him/tag/him follow his number - do whatever it takes!
- 4) Automatically forget everything and chase the guy off the screen.

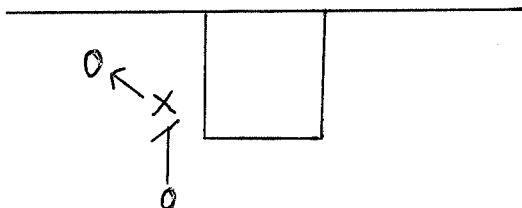

The curl is not as dangerous against pack.

If you are guarding the screener you are a one man zone - you open up and guard the basket. Get between the ball and the rim.

Downscreens

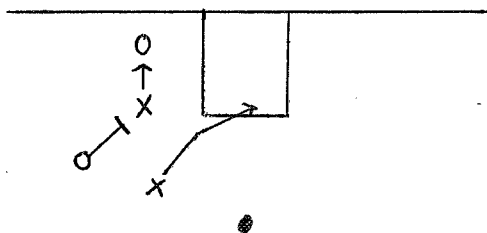

Crosscreens

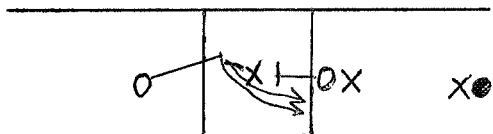

Chase even on back screens.

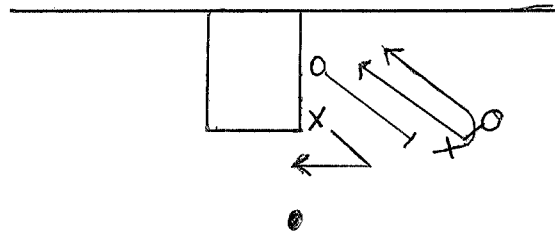

lock up on the guy and force him opposite his cut - 1001 and recover

Take an idea so it can be understood and apply it to all situations.

What you want done is more important than how it gets done.

When you are going to be screened - get to your man - it does not matter how.

Closeout with high hands - otherwise just get there in all other aspects.

Don't confuse with process - just get things done the way you want it finished.

SESSION III - More Defense:

4th coach in 5 years - 1st in state coach in a long time. The Governor called to pressure him about the job and to discuss the last possession against Purdue - mainly to talk about the last possession.

Recruiting at University of Wisconsin:

Good mental player is what he wants:

- mental toughness
- court awareness
- intelligence

Can have physical gifts or skills but must have mental part.

Bennett is not good at coaching players who do not have the mental part.

Results of an army study:

Three categories of soldier:

- 1) willing and able
- 2) unwilling and able
- 3) willing and unable

The first category - just give them their task and they will do it. Occasionally praise.

The second category - this group only workable approach was to tell them what you want done - nothing else. When they finish - give them the next task - spend as little time with these guys as possible - they are con artists. Don't fall over yourself to give them praise - just yank them out of the game.

The third category you must break the tasks down into smaller tasks they are capable of completing. Praise is good for these guys. This is the case with many high school players.

The kid who gives you his all - spend the time with him.

Make the opponent earn whatever they get. You can win the game - but you are going to have to beat us. Take away the easy stuff. Contest every shot and take care of the ball.

Don't play Pack Defense halfway. Reduce your recovery time by being in help. You can closeout on the shooters quicker when you are further away in correct help position.



Post Defense Note:

Xp will go over the top if possible on a reversal pass back on top. If he can't he must go underneath and regain correct position. Everyone else will pack.

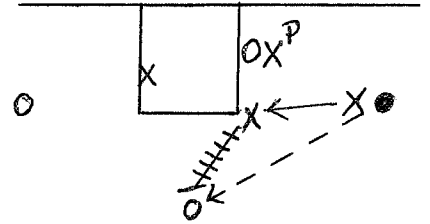

Review of Clinic Goal: Give Coaches something to think about.

Practice - you play like you practice
Game strategy is secondary to good practice.

Bennett has a vision of how the game should go. When the vision is not present on the floor - he comes alive. Otherwise he does not meddle. Preparation must come in practice.

Offensive skills are worked on as fundamentals
Defensive Breakdown situations to build anticipation
Team offense - whole work

Players must get themselves ready.

Work on offensive fundamentals individually with players.

Screeners Drill:

Does this everyother day in practice.

- 1) Offense must complete 10 passes.
- 2) Offense can do whatever it wants - within reason!
- 3) Can let the defense switch crosses - teaches the offense to basket cut.

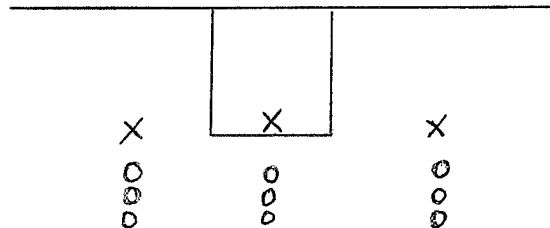

The first thing that goes against pressure is passing and catching.

Have a quick meeting.

Stretch

Goes hard with defense right out of stretching (Sivils note: we need to do this after shooting progression)

Defensive Breakdown Segment of Practice:

On ball defense: fullcourt 1-on-1 and/or halfcourt 1-on-1

- the emphasis is on keeping the feet apart and the ball in front of you.
- No one turns the corner!

Will go for as long as 10 minutes. Must practice 1-on-1 defense in order to be able to do it!

Going 1-on-1 everyday teaches the players how to adjust and force the offense to do something.

Fullcourt Help Drill: This drill is done everyday!

- 1) Line up in groups of 4
- 2) Get to help position
- 3) Closeout with high hands
- 4) Don't let them turn the corner
- 5) No lay-ups
- 6) Down & Back - Go for excellence
- 7) Do it till they get it.
- 8) Split or turn the corner the defense must scramble back and get the ball stopped. Can stop/freeze and correct.
- 9) Receivers cannot fly down the court.

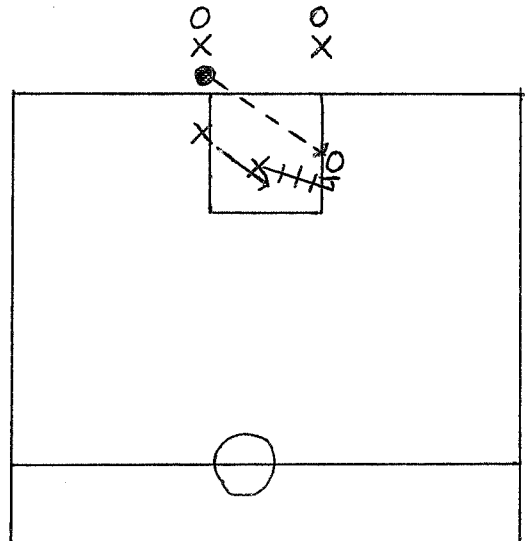

When do you recover?: When the dribbler starts to bring his off hand to the ball start your recovery.

3-on-3 Work off the ball:

Done for a total of 9 minutes - break the time up with each phase.

Three phases:

- 1) Freeze - offense catches the ball and freezes - defense corrects - do it a few times.
- 2) Play it out - offense plays - go without screens and go with screens
- 3) Finish the play - finishing defensively and adding the rebound
 - Coach will shoot it
 - whoever catches the coach's pass shoots it
 - make big time contact - if they don't fight release and pursue
 - if they fight keep after it.

Set the offense up in the set you want them to start from

(Sivils note: we would need to add outlet to this. Could let them go fullcourt some as a reward - work on primary breaks and transition defense)

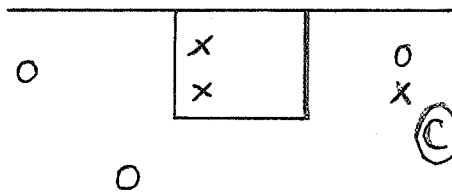

Defending The Double Staggered Screen:

- 1) The defender guarding the top screener jumps out momentarily to interrupt the pass and if possible force the cutter wide.
- 2) The defender guarding the bottom screener zones the play. He opens up and guards the rim and moves over/as far as the top screener.
- 3) The second defender must communicate that this is a double as soon as possible so the bottom defender is aware of it.
- 4) The defender guarding the cutter must get to his man as soon as possible and chase him.

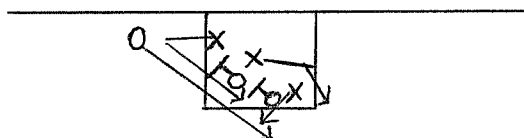

3-on-3 Closeouts:

Does this drill every 3rd night in place of OnBall and Help and Recover Drill.

Rules:

- 1) Offense has to stand and catch the ball
- 2) Offense has it easy getting rhythm shot or driving
- 3) Builds toughness
- 4) Can add post

The defense's biggest concern is getting to the shooter in time.

The first time you play the offense cannot shoot unless it gets the shot in the paint. (Sivils note: make this the first time each time we do this drill - then offense can freelance second time)

Second phase the offense can shoot the rhythm shot.

Third phase add post player.

Always finish the play defensively and with the rebound outlet.

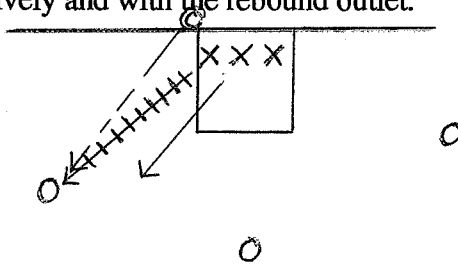

Rebounding from a ballside shot when dead fronting the low post:

Experience has taught Bennett that the post defender must go underneath. Seems logical that you would want to go over the top because the rebound will come out that way. What happens is that the offensive post pins the defender out from the goal and seals with good position. By going underneath the defensive post can seals the offensive post player out.

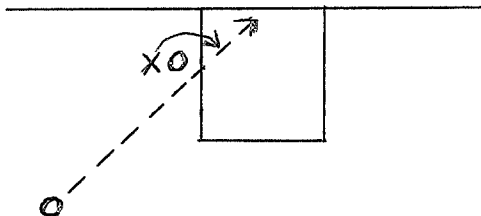

Dead Ball Situations:

When you get a dead call the on ball defender must smother the ball, crowd the pivot foot, and cross this hands high.

All other players *Dead Deny!* This is how you force turnovers in Pack!

Rally Defense:

Rally to the ball. Everyone collapses. Can make exceptions - i.e. stay home on a dead 3.

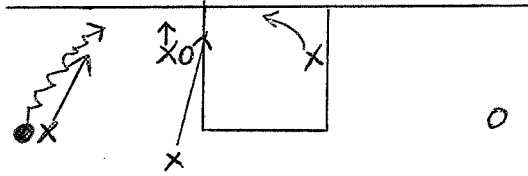

Rally Post Defense:

- 1) X3 & X4 are free to gamble
- 2) The low post defender spins to get between the ball and the goal.
- 3) Swarm the ball with the ballside defenders.

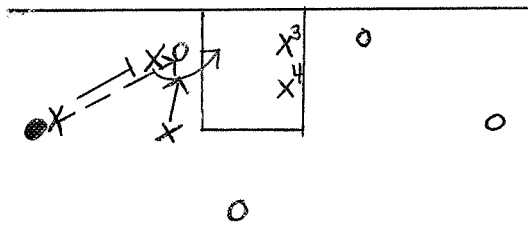

Bennett On How Smart You Have To Be To Play For Him:

If you have a pit bull on one leg and a poodle on another doing what it is they do on bushes - you have to be smart enough to know which one let finish.

Next stage is defensive conversion.

Then they spend 15 minutes working on shooting.

Defensive situations comes next.

4-on-4 shell drill situations

Will set up in opponents offense and work on how he wants a particular breakdown defended.

Does not tell team that they are working on opponent. Wants them concentrating on the defensive situation so they will recognize it in the game and anticipate well.

i.e. Covering the flex cut

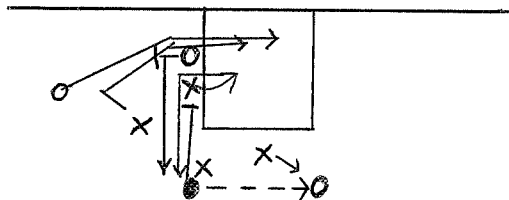

The next segment of practice is the offensive whole segment.

Late in the game when behind would play hard against the inbounds - possibly trap the first pass
Then will go to push in halfcourt D.

Fullcourt Man-to-man Press With 3 Defenders:

- 1) Do not let the ball up the outside
- 2) Trap the ball in the middle and rotate
- 3) Sivils note: because the trap is more predictable(?) may be able to rotate up a defender with more ease.
- 4) The big kid is in a zone protecting the rim

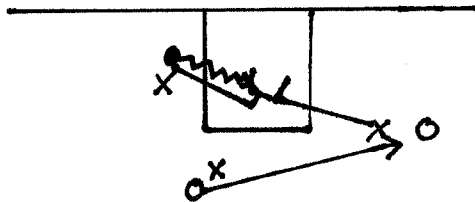

X
X Big Kid

Bennett's 1-2-2 Zone:

Likes this because it really looks like pack and hard to tell what defense they are in. Loves it when he listens to the television commentators because they are too stupid to tell if they are in pack or zone.

- 1) Does not need a lot of work in practice.
- 2) Go push on dead balls
- 3) Baseline players play out high from the baseline.
- 4) Point sits on the high post area.

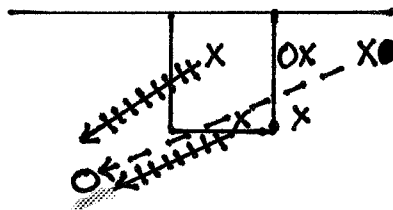
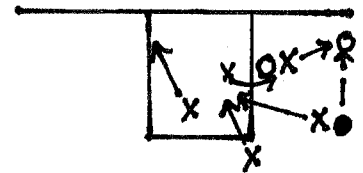
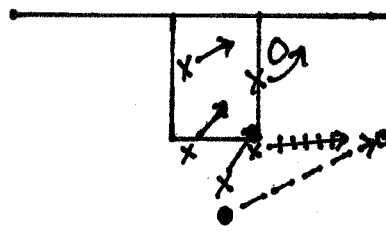
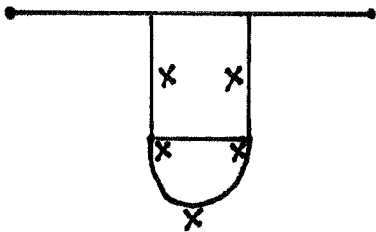

If you give up ball rotation - you must be great at closing out. Must be able to defend the ball.
Point covers the diagonal skip pass until the wing can make it out.

End all practices with a rebounding drill.

If you can:

- 1) be sound in most possessions
- 2) eliminate the high percentage cuts for the opponent
you have a chance!

Sometimes you'll do everything right and get beat - just come back tougher - outlast people.

SESSION IV: Offense:

Be boss (sic?) with the basketball- He'd feel good!
Add passing and catching and he'd feel great!

Boss drills - taking care of the ball 1-on-1 play
- 1-on-2 play - this perimeter type play

Bennett doesn't want to build confidence - wants them to struggle (Sivils note: this will build more and better confidence in the end!)

Must know who they are - this gives them two choices - blame everyone or get tougher!

They'll choose Option A at first but Option B is the way to go - makes them and the team tougher.

In order to break most defenses down you have to get the ball from side to top to side and back - this is how you really break down the defense.

Sell your vision of how the game is to be played.

Identify roles for your Players!

Need 3 screeners against great teams so you can always have two guys always screening.

Two permanent Blockers - designate areas

When a mover gives up the ball - he is for one pass a screener.

Blocker's must be smart:

- 1) screen and rescreen
- 2) screen and separate
- both are correct but they must be quick to do it
- 3) If switching go to the defender and then step into an opening.
- 4) Blockers are originators

Top-High Blocking With A Permanent Post:

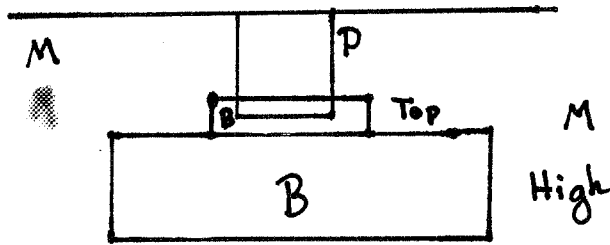

Not sure of anything anymore. Everything Bennett does is subject to question. Constantly looking for a better way of doing things. Thinks it is critical to go through this process. You'll never arrive but the process is important.

Eight is about all you can play. One of those 8 is a straight up back-up point guard.

If you play a 5 man unit for 2 or 3 minutes in the first half (purple gang at Steven's Point and the green gang at UW-Green Bay) you can do it in the first half. But the second half you cannot do it.

Don't try to make people happy. Take the heat - kids want consistency. Starters need continuity. In the end everyone will accept what you decide if you are consistent.

Against great pressure - make them chase early. Blockers stay in area but come out high and really NAIL people early.

VS Zone:

Top Bottom Blocker

The bottom blocker screens in either the top corner, hoop man, or sets a CS screen.

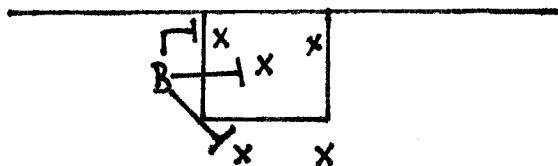

Can have a permanent screener against zones.

Can screen inside out

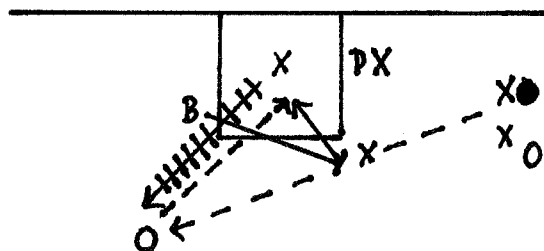

Blockers key the offense. They will seek the mover's man in their area but the mover has to take their man to him.

Blockers key where the opening is.

Blockers should take pride in getting guys open. They can also get shots from their screens.

First Practice:

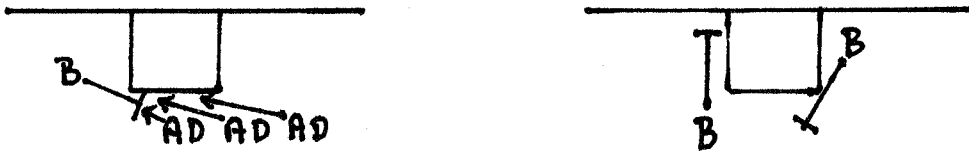

Have air dummies move into the screener from different angles.

Try tie up the defenders feet, esp. his lead foot.

They can work on shooting off their screens. In practice when working on the mechanics of cutting let the blockers - NOT THE MOVERS - shoot off the second cut. This teaches the blocker he will get open for a shot and force the movers to work on the mechanics of cutting and using the screen. If you let the cutter shoot he will think about shooting and not cutting/using the screen.

Tell them if they do not like the role of blocker that is fine - just do not expect to play at all.

Wide wide is susceptible to switching.

Burn them quick inside on help.

Against a zone the top blocker - a point guard - must stay one pass away.

Against a zone or man by bringing the point guard back - it sets him up to penetrate.

Really good point guard are not concerned with their own stats. They are concerned with winning and fixing the offense -mechanics.

Also keeps your point guard back on Defense!

Top - High

Top blocker works the elbows and sets down screens (Sivils note: could set backscreens for perimeters for a UCLA cut)



Movers move - they hunt the shot. It is their job to score. Must do what it takes to get defense's attention.

Movers must spread out - Esp. important that if a mover has a ball at the wing one must not be below him - exception would be our permanent post man.

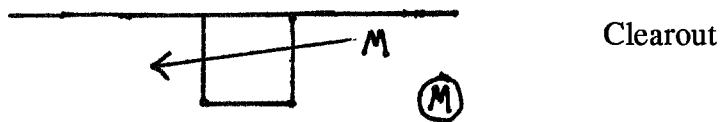

Dean Smith quote: "If you have great players you can put them in any offense and they will make it work. If you have limited players - they need a great deal of freedom on offense. Then teach them the necessary shot selection to complete plays."

Run In Such A Way As To Win ... I Cor.

Doesn't worry about criticism - just plays in such a way as to win...

Motivation is an ongoing thing...

Screeners must talk to the movers

Mover has to think about how to get open off the screen.

Getting open is like playing tag.

- 1) Tell O to get away from him. Play tag.
- 2) Now add a screener. Tell them to get away and create space. Don't confuse with lots of instruction. Worry about the finished product as compared to the vision.

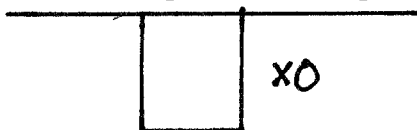

- 1) Get open
- 2) Square feet/fight for feet
- 3) Then catch and shoot

Must learn to fight for your feet. Feet have to be “open” to shoot. You can shoot when you can catch the ball square. - Tony Bennett

Bennett feels early in the season his team at U of W must get good shots early in the season. They must show this ability early.

T Area Motion:

Three players in the T Area

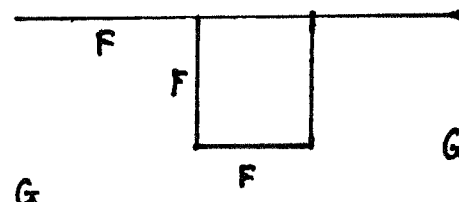
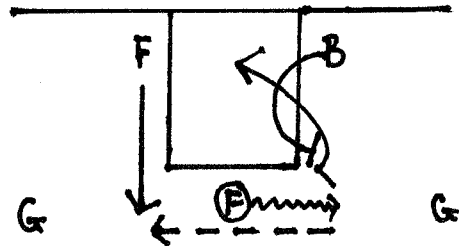
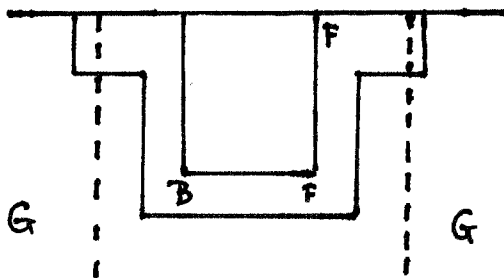

This is great against zones.

Problem is the guards get antsy.

Against a zone, if you catch the ball inside and don't have a shot go weakside fan with the ball.

You can shallow cut or screen the interior with your two perimeters.

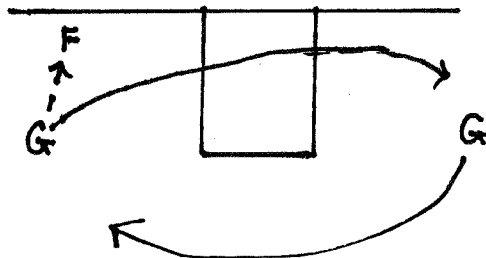

Yellow/Green/Red T Area Motion: this is what he plans to use at U. of W.

Yellow: Regular T Area Motion

Green: Everybody gets the off guard open - everybody off the ball is temporarily a blocker

Red: Under 10 seconds left on shot clock - one of two options

Red continued:

- 1) come out and set a ball screen
- 2) get the ball to a guard and flatten out on the baseline with a 4 across

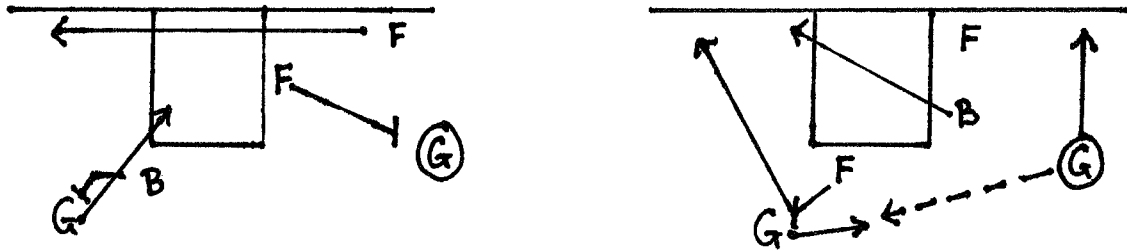

Green Option:

- 1) When the ball is dribbled up (centered on top) all forwards read this and become blockers for one pass. They must really nail the off-guard's man. Can set a wall or a triple stagger. Just need to nail the defender.
- 2) Teach the off guard to make good decisions.
- 3) Blocker's revert back to T Area Motion with three man moving and screening.
- 4) Ball guard who made the pass must balance the floor out.

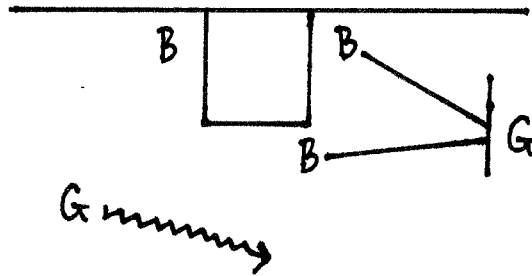

Entering T Area Motion Offense:

- 1) The ball should be centered - Run *GREEN* to start the offense
- 2) Everybody gets the off guard open
- 3) Yellow regular after first pass
- 4) *Red* with under 10 seconds on shot clock
 - Bennett like/wants them to come out and screen the ball
 - Must clear out the side in a hurry if this happens on a side

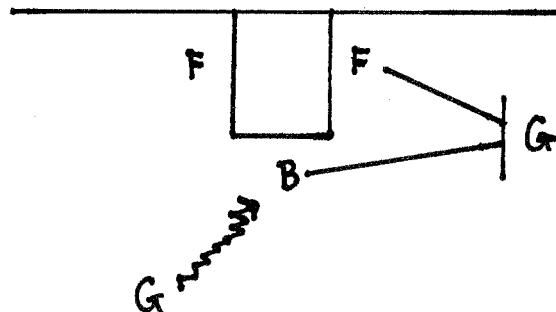

Wants to start the offense with *Green* so he can create a lot of movement fast.
 Go *Yellow* once your guard has the ball.

Can also run *Green* if the ball cannot be reversed.

Following are possibilities for T Area Motion. Diagramed from tape Coach Bennett Showed of UW-GB. There is one blocker in the three man motion.

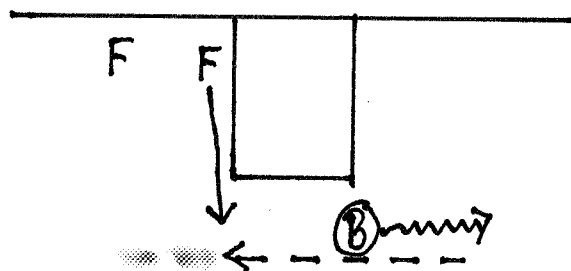
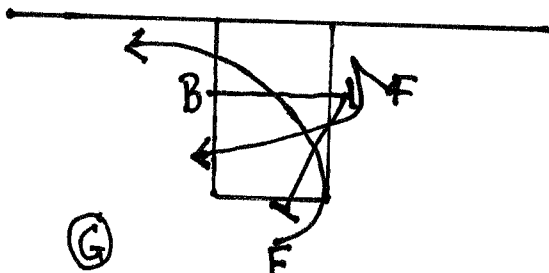
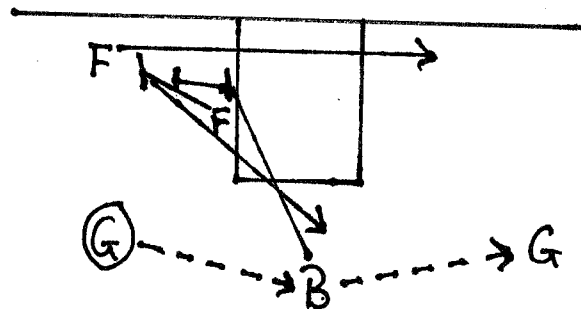
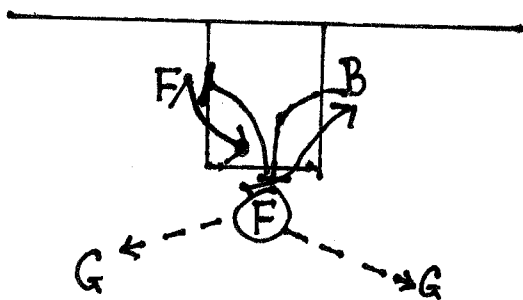
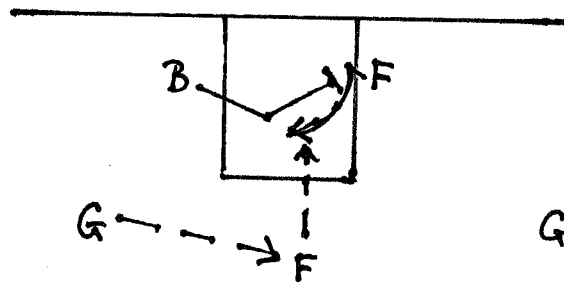
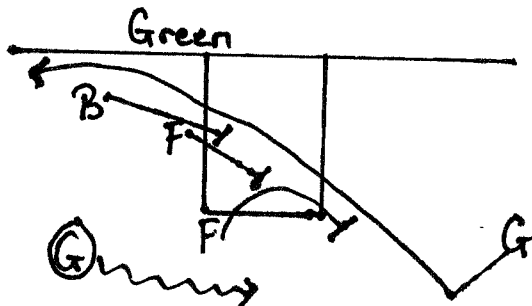
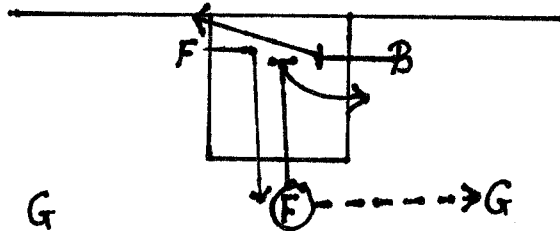
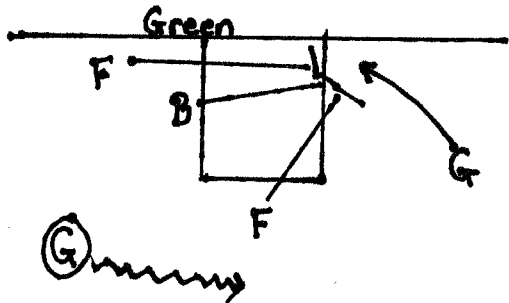

Most guard shots must come off inside/outside play. Following are options diagrammed off Coach Bennett's game film.

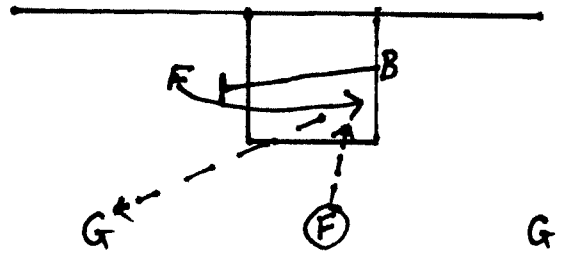
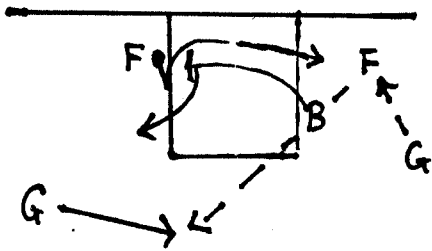
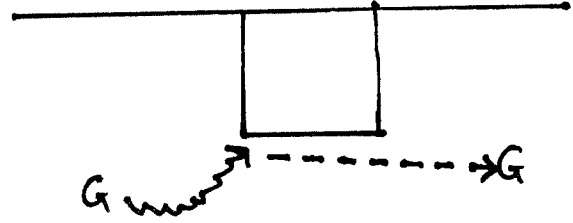
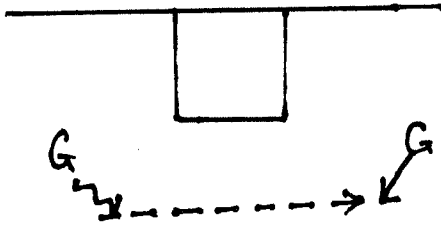

Bennett's Wisconsin Zone Continuity Offense:

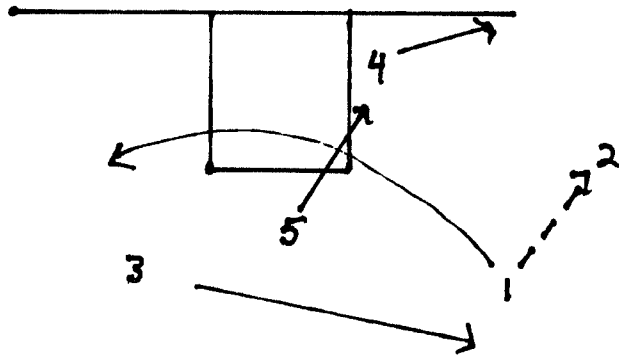
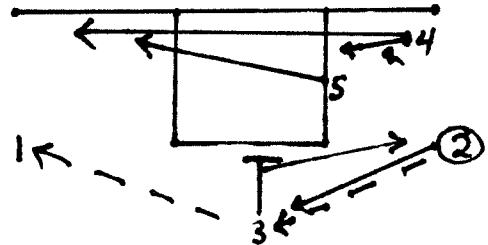
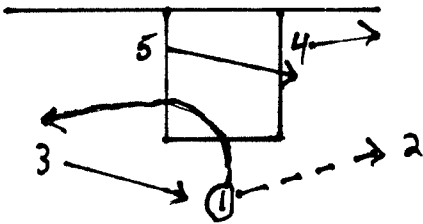

Bennett's Fullcourt Press Offense:
Look for skip passes.

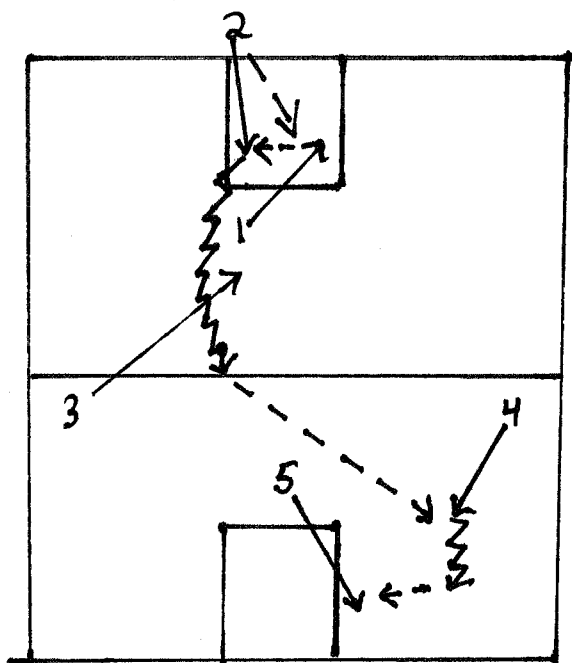
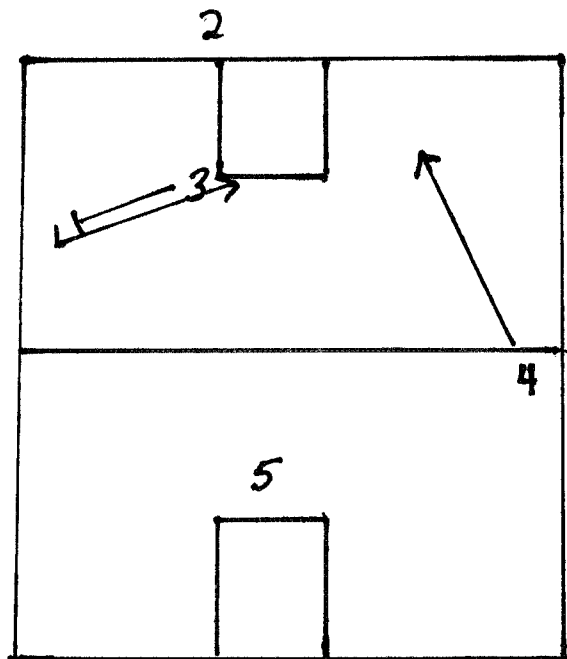
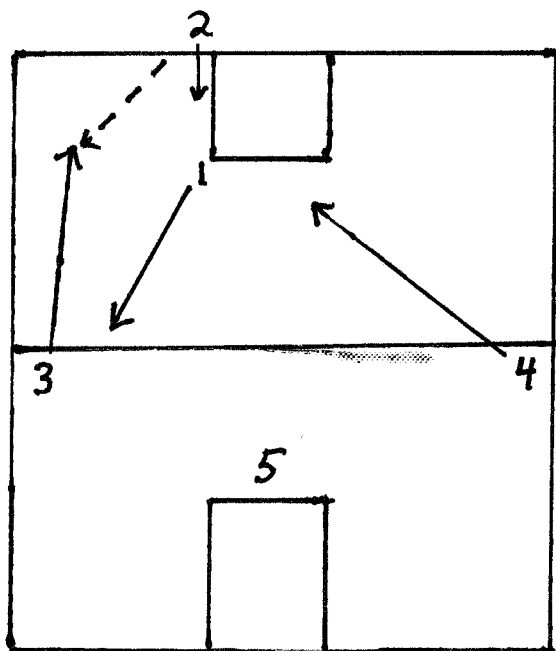

Developing Teams Is The Coach's Job!!!

Developing players is the player's responsibility!

Teambuilding Process:

1st step: Training/drilling - good athlete want to skip this part- this is what keeps them from being as
as they could be.

2nd step: Competition is vital

- gives you a chance to learn from your failures

3rd step: Evaluation

- tell them how they're doing

- kids tell you how you're doing

- trust involved here

MUST BE WILLING TO GROW FROM FAILURE!!!!

Tape practice - notes to players from practice.

Bennett coaches to fulfill a creative need - not because he wants to be with kids. They are important
to him but they are not the main thing.

When the questions stop coming it is time to look at yourself.

Bennett left UW-GB because he needed to question again - needed to struggle.

Doesn't think he is up there with the Knights and Keadys etc. - but will learn to do this.
Wants to compete.

Realized how limited he is - has increased his faith in God - Needed vulnerability and to stretch.

Pro's have the players. But the game is at the college and high school level.

Sivils Note: Coach Bennett was exhausted when he finished the clinic. Had put everything he had
into it. Worked hard so the coaches could have a great clinic and have some things to think about.

Was very impressed with his humility. When I introduced myself to him he recognized my name
from

my having written to him several times and having talked with him on the telephone as well.

Remembered that Runnels was a small school but had had some good play-off success.

Impressive. Went to the All Star games. Was very excited to see them - even the girls all star game.

Super individual!!!!